

# The **Pink Lat Pack**<sup>™</sup>

## Quick Setup Guide

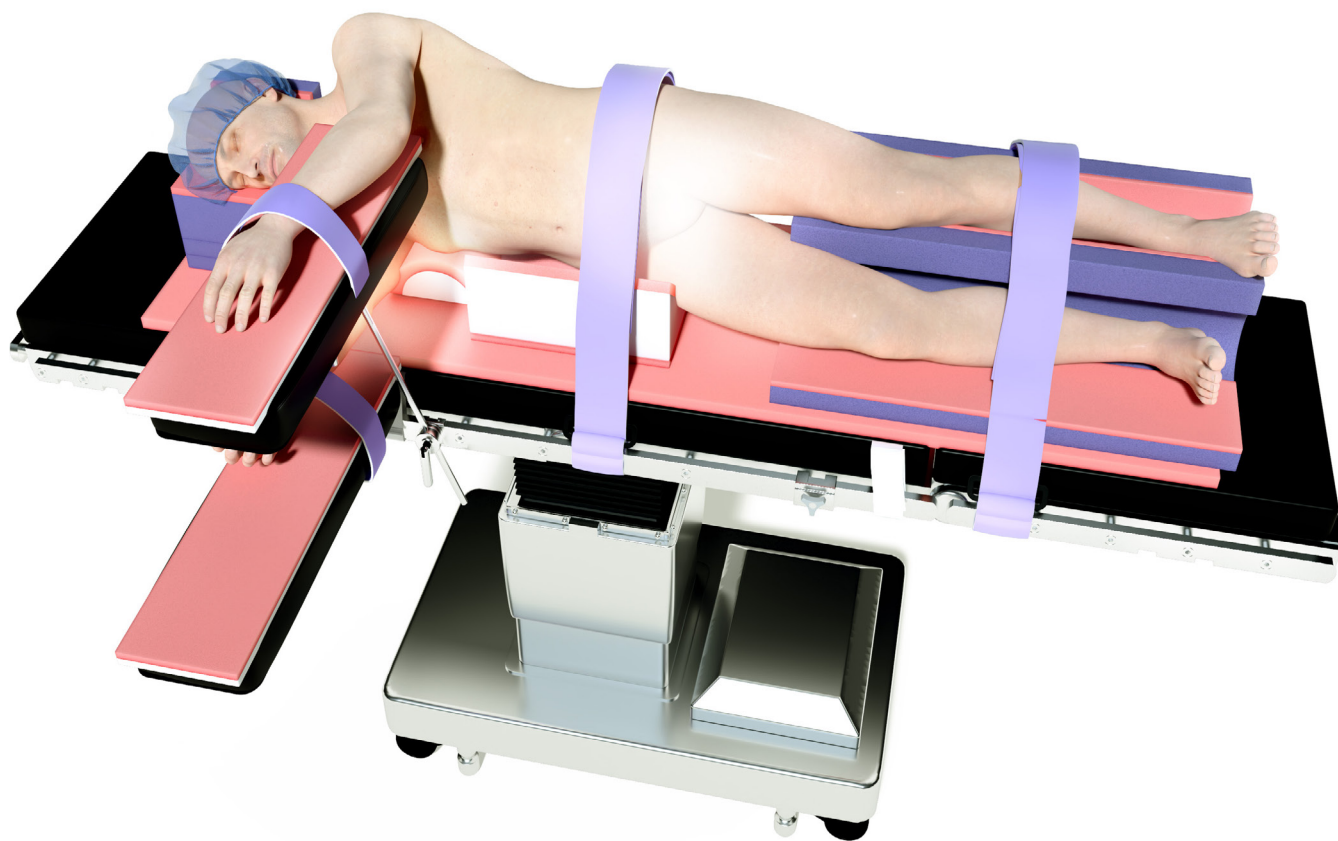

# Full Flank Lateral Positioning

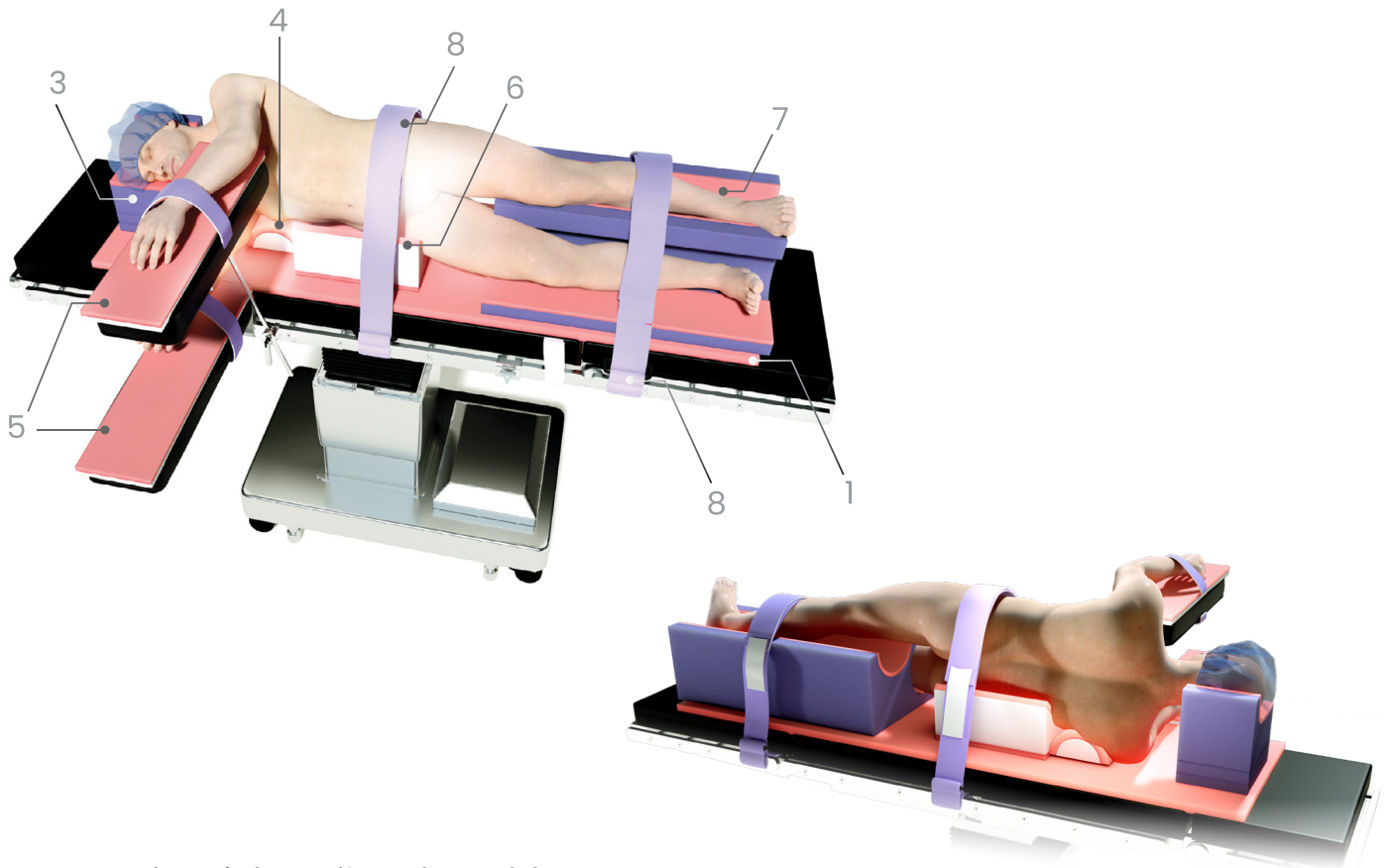

1. Strap The Pink Pad® to the table
2. Remove the lift sheet once patient is positioned laterally
  - This helps maximize skin protection and allows wedges to lock to the Pink Pad
3. Place the #40471 Adjustable Lateral Head Positioner
4. Place the #40544 Pink Arc Positioner (axillary roll)
5. Position and protect arms (various options available)
6. Place the #40947 Low Profile Lateral Wedges, one in front and one behind the torso
7. Place leg positioner of choice
  - If using the #40941 Lateral Dual Leg Positioner (leg shelf), position slightly above the knee so ankles are fully supported
8. Secure the patient with body straps across the hip and legs

\*If using steep Jack Knife, the #40946 Tapered Intra-Leg Positioner is recommended

# Full Flank Lateral Positioning + Jack Knife

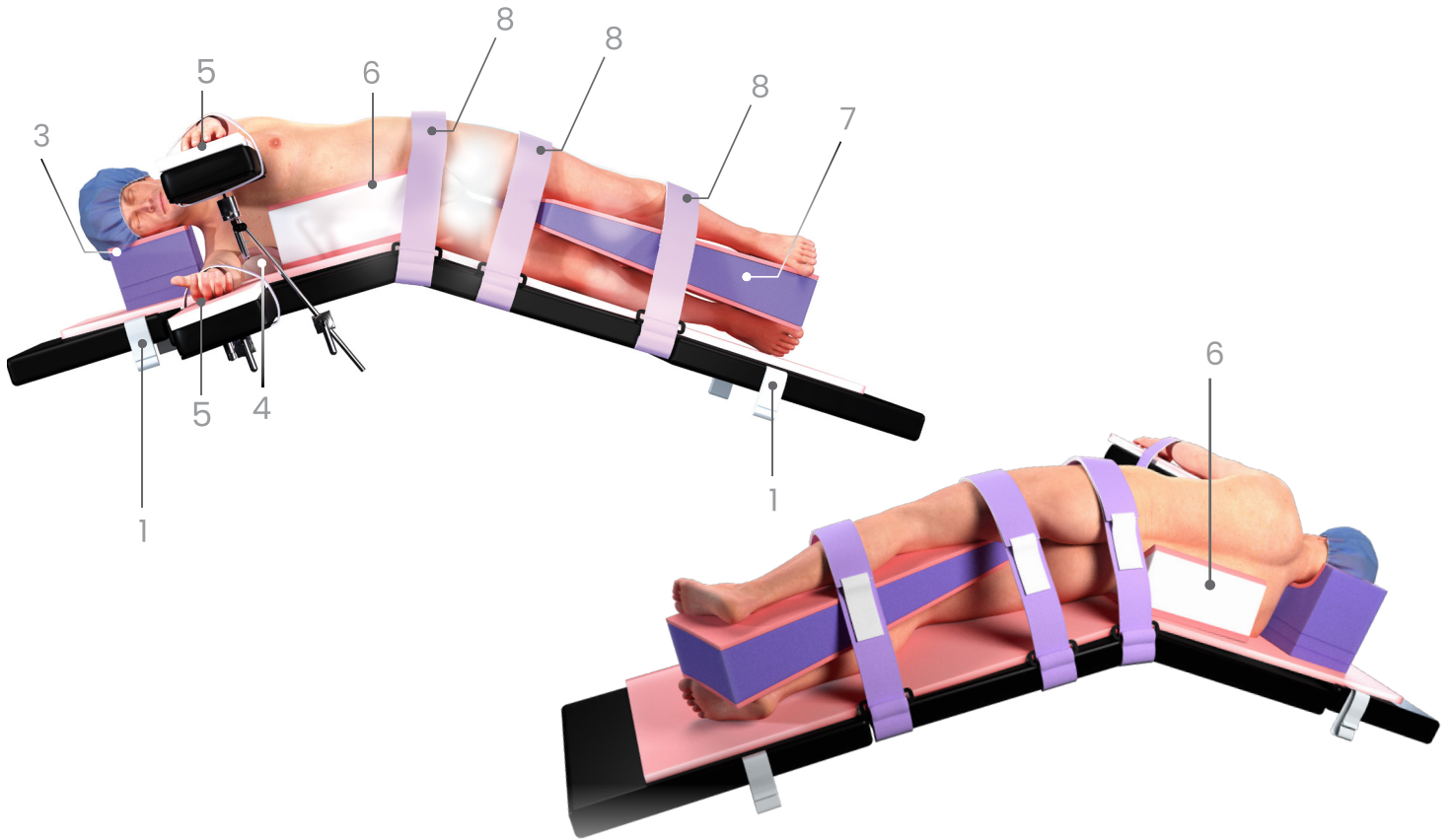

1. Strap The Pink Pad® to the table
2. Remove the lift sheet once the patient is positioned laterally
  - This helps maximize skin protection and allows wedges to lock to the Pink Pad
3. Place the #40471 Adjustable Lateral Head Positioner
4. Place the #40544 Pink Arc Positioner (axillary roll)
5. Position and protect arms (various options available)
6. Place the #40947 Low Profile Wedge, one in front and one behind the torso
7. Place the #40946 Tapered Intra-Leg Positioner
8. Secure the patient with body straps across the hip, middle of thigh, and middle of calf

# Modified Lateral Positioning

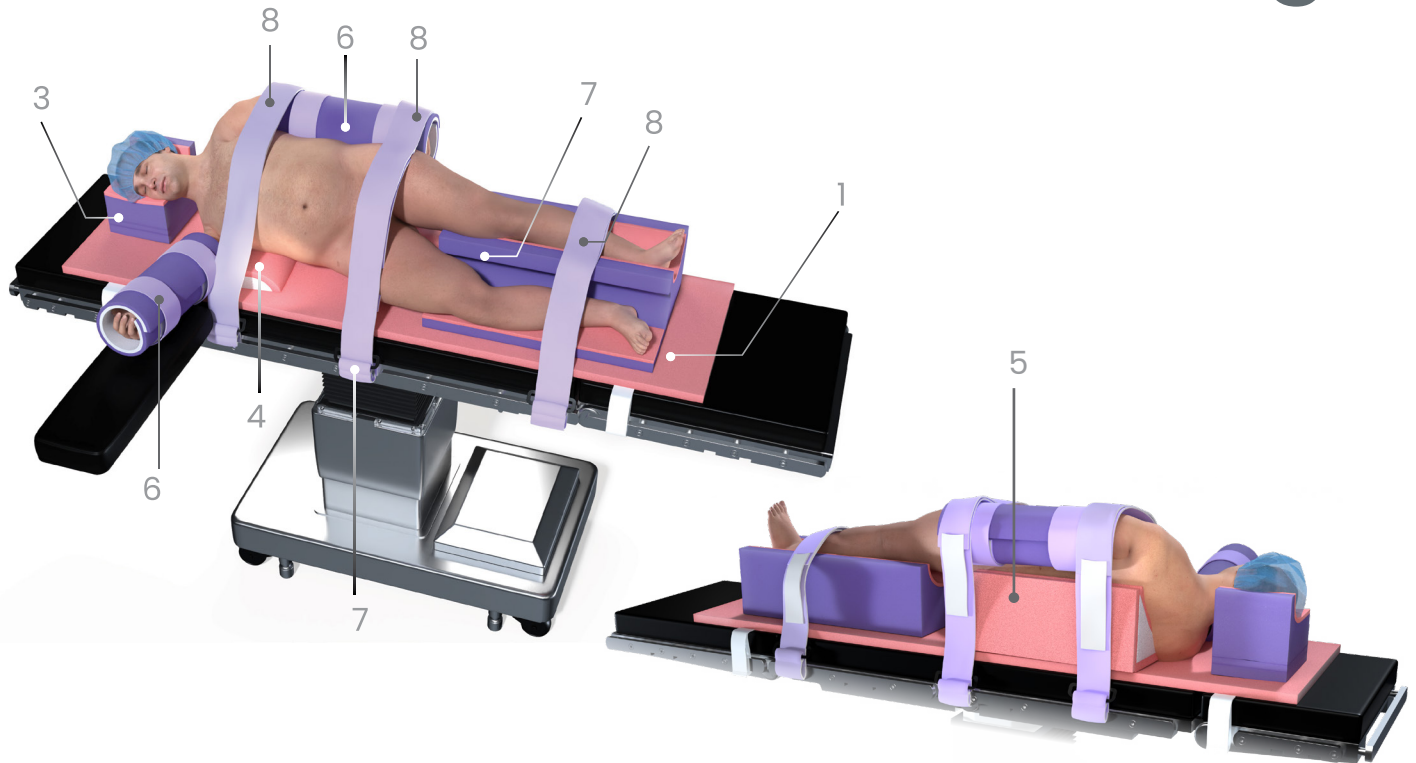

1. Strap The Pink Pad® to the table
2. Remove the lift sheet once the patient is positioned laterally
  - This helps maximize skin protection and allows wedges to lock to the Pink Pad
3. Place the #40471 Adjustable Lateral Head Positioner
4. Place the #40544 Pink Arc Positioner (axillary roll)
5. Place Multi-Angle Wedge to preferred degree of modified lateral to back of torso
  - #40948 Multi-Angle Lateral Body Wedge (small)
  - #40942 Multi-Angle Lateral Body Wedge (large) \*recommended for high BMI patients and/or use for placement of top arm alongside patient's torso
    - If additional surface area is required, an armboard may be placed along side the table beneath the body wedge
6. Position and protect arms (various options available)
7. Place leg positioner of choice
  - If using the #40941 Lateral Dual Leg Positioner (leg shelf), position slightly above the knee so ankles are fully supported
8. Secure patient with body straps across chest, hip, and legs

# Modified Lateral Positioning + Jack Knife

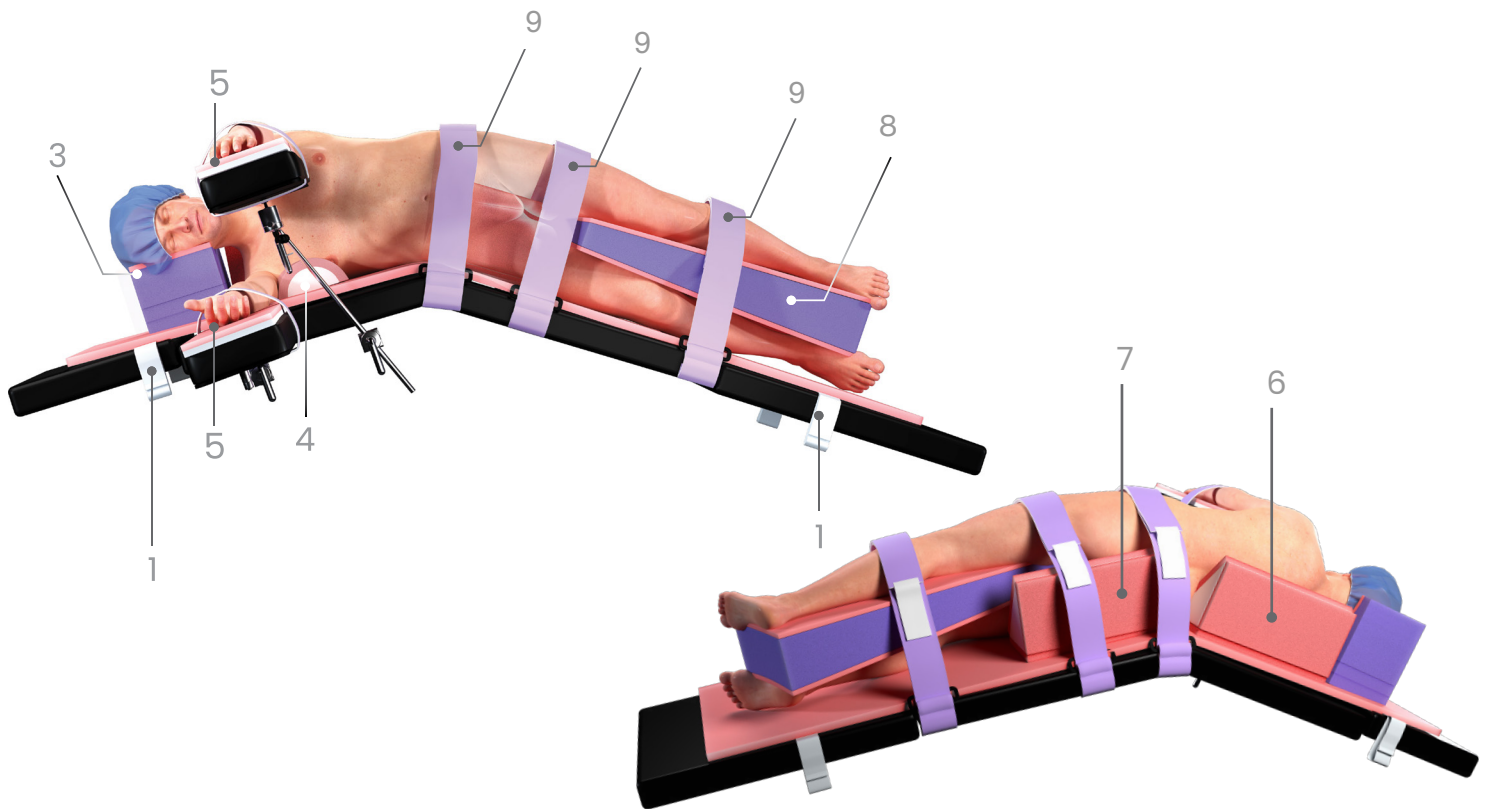

1. Strap The Pink Pad® to the table
2. Remove the lift sheet once the patient is positioned laterally
  - This helps maximize skin protection and allows wedges to lock to the Pink Pad
3. Place the #40471 Adjustable Lateral Head Positioner
4. Place the #40544 Pink Arc Positioner (axillary roll)
5. Position and protect arms (various options available)
6. Place the #40948 Multi-Angle Lateral Body Wedge (small) behind the torso
7. Place the #40948 Multi-Angle Lateral Body Wedge (small) behind the gluteal region
8. Place the #40946 Tapered Intra-Leg Positioner
9. Secure the patient with body straps across the hip, middle of thigh, and middle of calf

# GENERAL INSTRUCTIONS FOR USE: THE PINK LAT PACK™

**BEFORE USING PRODUCT, READ THE FOLLOWING INFORMATION THOROUGHLY.**

## DESCRIPTION

The Pink Lat Pack™ is a single use system for use in lateral surgical procedures. The system consists of a proprietary formulation for the pink foam pad, non-woven lift sheet, body straps, head positioner, body wedge, armboard pads, arc positioner and an intra-leg positioner.

## INDICATIONS

The Pink Lat Pack™ is a single-use, non-sterile device to be used during surgery to provide patient protection from injury.

## INTENDED PURPOSE AND USER

This device is intended for use by trained healthcare professionals only to provide patient protection from injury during lateral surgical procedures.

## CONTRADICTIONS

This device is not designed, sold, or intended for use except as indicated.

## KNOWLEDGE AND USE

Professional use requires knowledge of this instruction for use. Device use limited to surgical operating room in a hospital or surgery center.

## CLINICAL BENEFITS

To aid hospital facilities in providing a safe and effective method of management of the patient for pressure injuries and non-movement for patients in the lateral position.

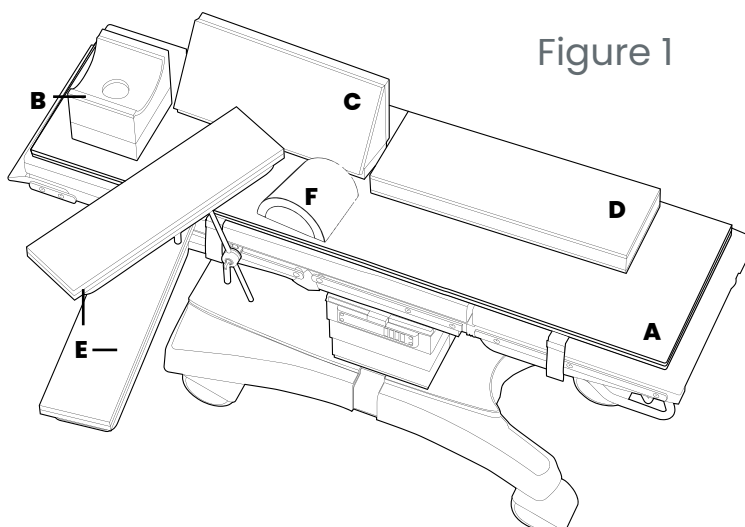

Figure 1

- A. Pink Pad EXT™
- B. Adjustable Lateral Head Positioner
- C. Multi-Angle Body Wedge
- D. Intra-Leg Positioner
- E. Armboard Pads with DermaProx™
- F. Pink Arc Positioner

## PREPARATION AND USE

1. Make sure the O.R. table is level and in position. Lay down Pink Pad® EXT on the entire O.R. table and attach the Pink Pad® EXT to the O.R. table according to the Pink Pad® EXT Instructions For Use. (*Figure 1*)
2. Lay Adjustable Lateral Head Positioner on O.R. table relative to where the patient's head will lay. The hole in the head positioner is where the patient's ear should end up. The taller part of the head positioner should encompass the back of the patient's head. (*Figure 1*)
3. Begin positioning the patient on their side. Tear away perforated part of the head positioner as needed.
4. Put Multi-Angle Body Wedge behind the patient so that the wedge supports the patient's back while in lateral position. Use the 35°, 55°, or 90° angle depending upon the surgeon's preference. (*Figure 2*)
5. Place the patient's down arm on the armboard Pad with DermaProx™ on top of the armboard with their palms facing up. Attach each arm board strap to the armboard and patient's arm between patient's wrist and elbow. Depending on the table set up, place the patient's up arm on the armboard Pad with DermaProx™ on top of the limb holder. (*Figure 2*)
6. Place the Standard Pink Arc Positioner between the 7th-9th rib to protect the dependent arm from injury.
7. Lay Intra-Leg Positioner on top of the patient's bent leg so that it lays in between the patient's legs; ensuring the knees and thighs do not rub against one another. (*Figure 2*)
8. Use remaining body straps to secure the patient at locations the surgeon prefers or per hospital protocol. Attached body straps by following the steps below:
  - A. Secure both portions of the two-part body strap to the accessory rails.
  - B. Identify each portion of the strap – Part A has a small hook & loop square and Part B has a long hook & loop tab. (*Figure 3*)
  - C. Beginning with Part A, orient the strap so that the small hook & loop square is facing outward, away from the table. Draw the end of the belt up between the table and the accessory rail and lay the free end over the table.
  - D. Repeat the procedure with Part B of the strap on the other side of the table, ensuring that the hook side of the long hook & loop tab is facing inward toward the pad
  - E. Join straps together with the long hook & loop tab of Part B on top of Part A.
8. If applicable, jackknife/tilt table to desired position and begin procedure.

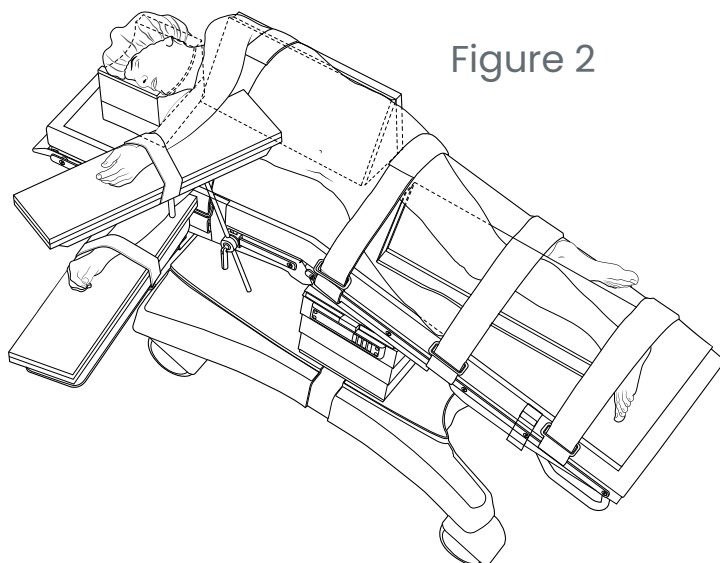
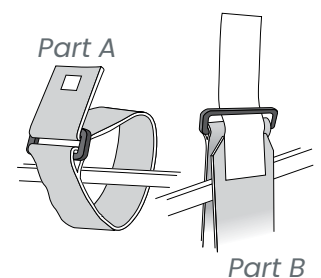

Figure 3



## DISPOSAL

- After use, The Pink Lat Pack should be disposed of in accordance with hospital policy.

## WARNINGS

- This device was designed, tested, and manufactured for single patient use only. Reuse or reprocessing of this device may lead to its failure or subsequent injury.
- Reprocessing of this device may create the risk of contamination and patient infection.
- Do not reuse or reprocess this device.
- After use, The Pink Lat Pack should be disposed of in accordance with hospital policy.
- The Pink Lat Pack should be stored in a clean, dry location at room temperature prior to use. Avoid prolonged exposure to elevated temperatures.
- Please visually inspect for breaches of packaging integrity prior to use. Do not use if damaged, opened, or breached.
- USA Federal law restricts this device to sale by or on the order of a physician.

## PRECAUTIONS

- The Pink Lat Pack should be used in accordance with the instructions for use and any contraindications, warnings, or precautions provided by the manufacturer of the associated instrument.
- Before using The Pink Lat Pack, ensure that the O.R. table pad is securely affixed to the O.R. table and is clean and free of residue.
- Be sure to follow your facility's policies and guidelines for frequency of patient monitoring. Check skin for integrity and proper circulation. Product is to be used by licensed medical professional only.
- Care should be taken to safeguard The Pink Lat Pack from exposure to prep solutions.
- Notice to the user and/or patient that any serious incident that has occurred in relation to the device should be reported and the competent authority of the Member State in which the user and/or patient is established, as well as, Xodus Medical and its Authorized Representative.

## TECHNICAL SPECIFICATIONS

- Materials of manufacture include:
  - » Polyurethane foam, synthetic adhesive, nylon strap
- Shelf Life – indefinite

## STORAGE, TRANSPORT, AND OPERATIONAL CONDITIONS

- The Pink Lat Pack should be stored in a clean, dry location at room temperature prior to use. Avoid prolonged exposure to elevated temperatures.
- During ALL handling and storage, assure that the pad is flat. Do not roll or fold the pad.



702 Prominence Drive  
New Kensington, PA 15068,  
United States

xodusmedical.com  
info@xodusmedical.com  
Tel: 1+724-337-5500

FDA REGISTERED  
ISO 13485 CERTIFIED



MADE IN THE  
USA

LITIFULP003 R1 1/16/2024





**XODUS MEDICAL**

Making Surgery Safer™